

burda Download-Schnitt

Mod.17 aus easy fashion E993

Übersicht der Druckseiten

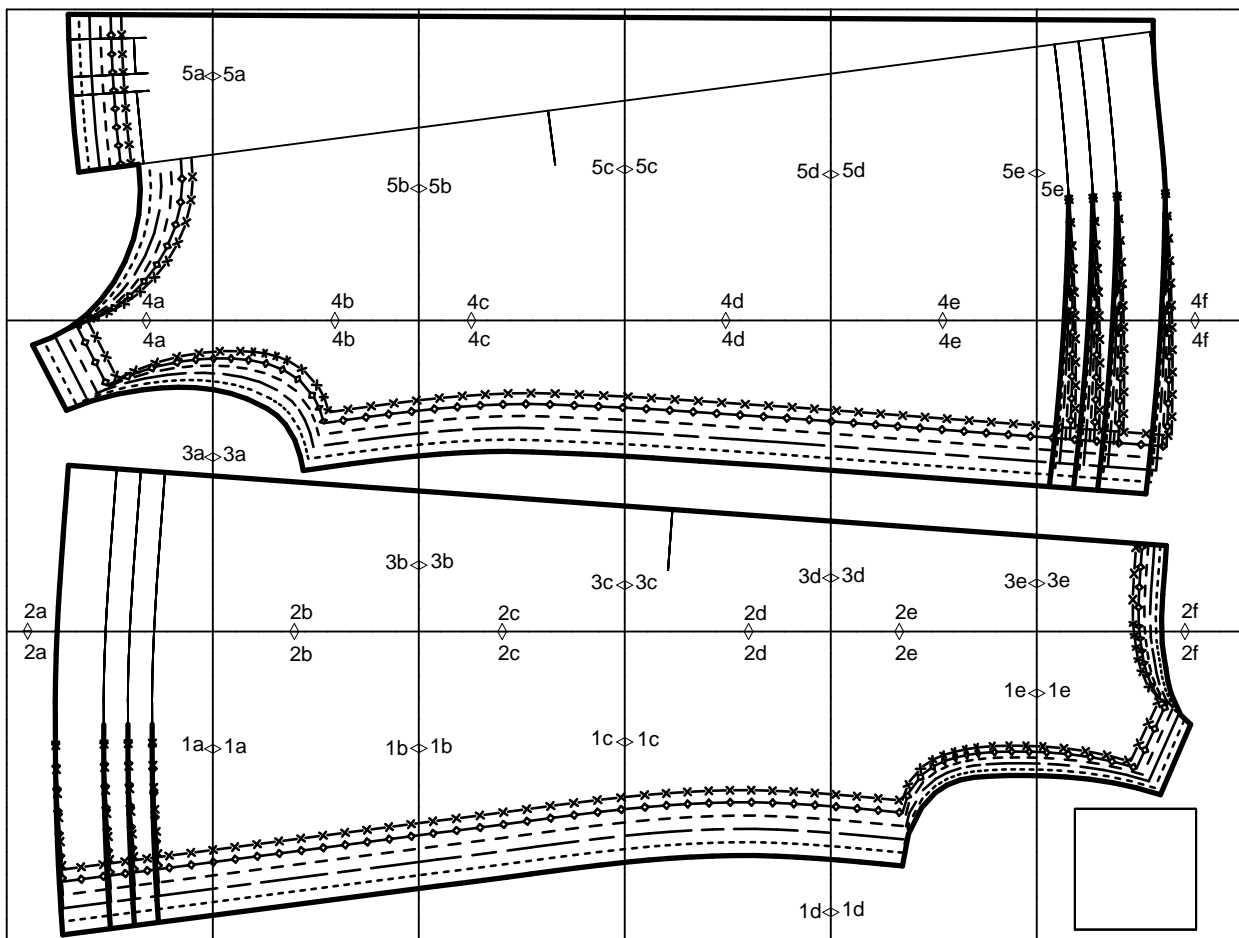

Copyright 2009 by Verlag Anne Burda GmbH & Co. KG, Am Kestendamm 1, D-77652 Offenburg
Sämtliche Modelle, Schnittteile und Zeichnungen stehen unter Urheberschutz, gewerbliches Nacharbeiten ist untersagt.
Der Verlag haftet nicht für Schäden, die durch unsachgemäße Handhabung des Schnitts, der Materialien,
unsachgemäße Ausführung der Tipps und Anleitungen oder unsachgemäße Nutzung der Modelle entstehen.

2a

1a

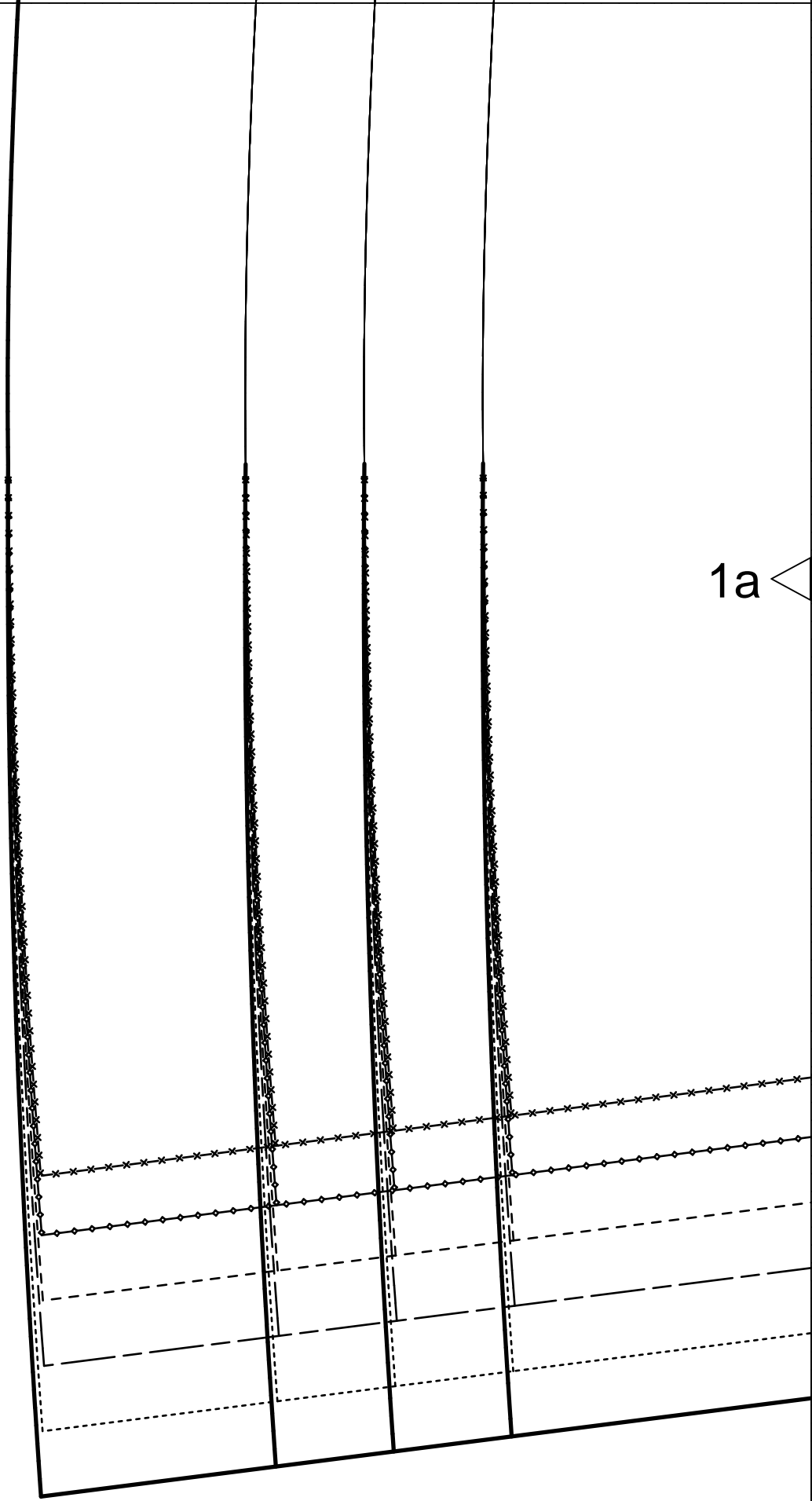

2b

1a

1b

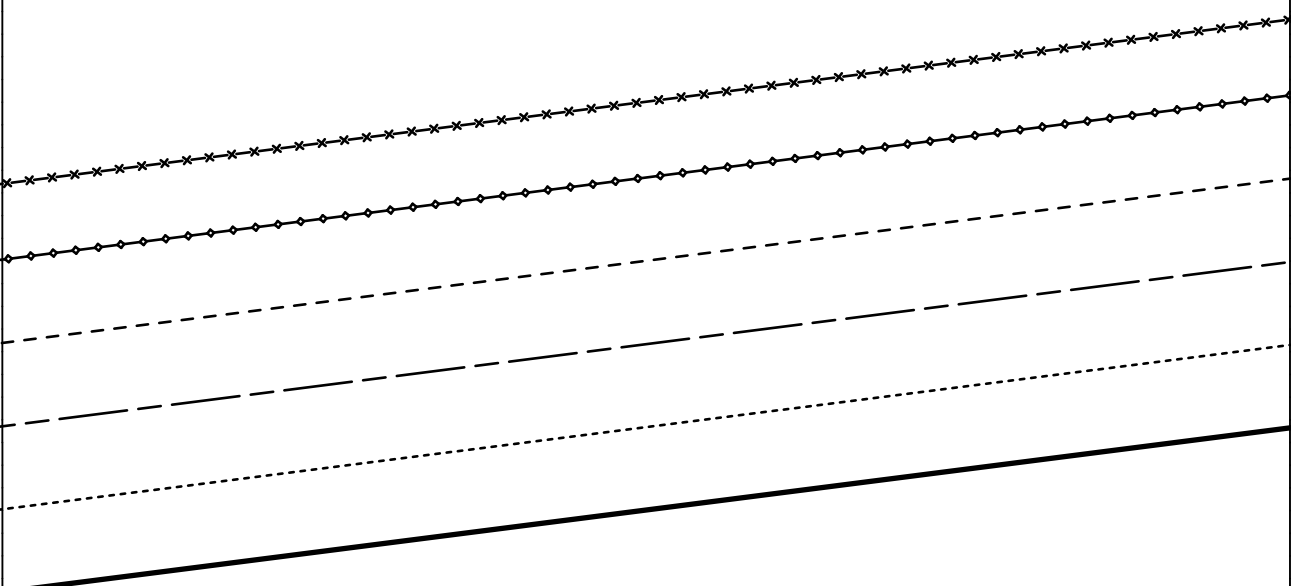

2c

1b

1c

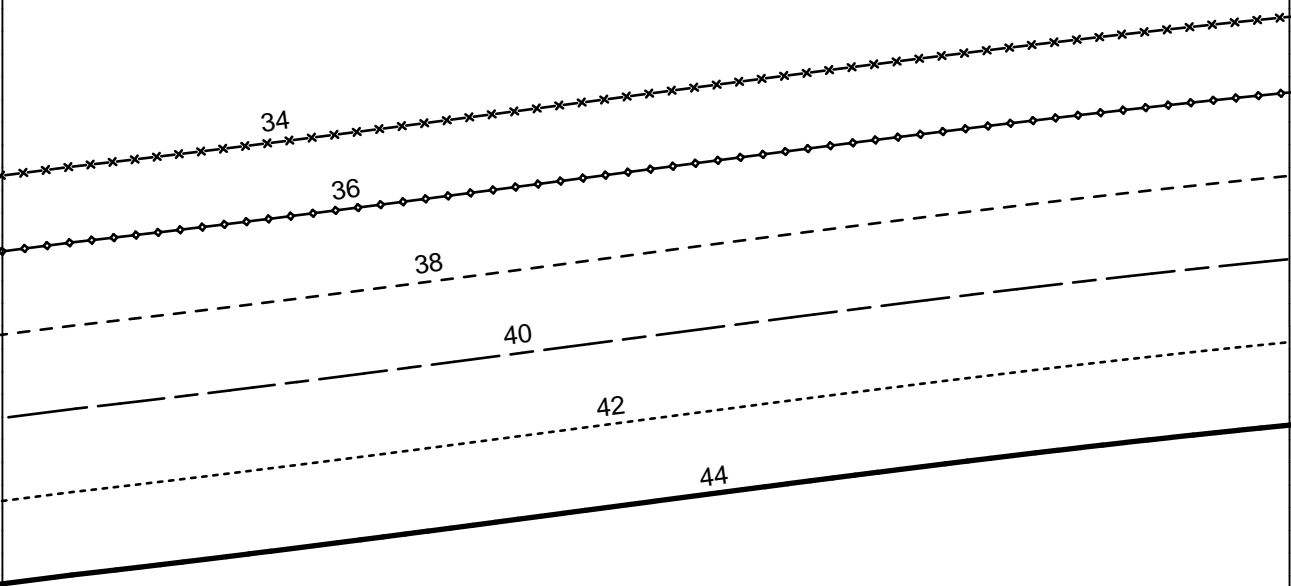

2d



1x

im Stoffbruch / Stoff + Futter
on the fold / fabric + lining
СЛИЗ ТКАНИ / ТКАНЬ + ПОДКЛАДКА

Mod. 17

burda[®]
www.burdastyle.com

2

Rückenteil

back

СПИНКА

A,B,C

1c

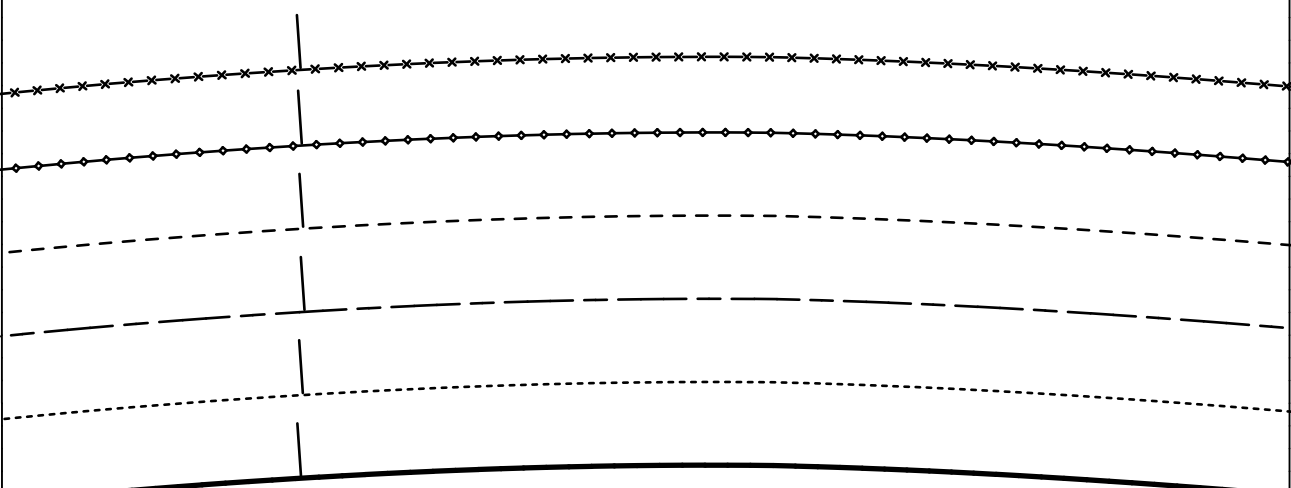

1d

2e

1e

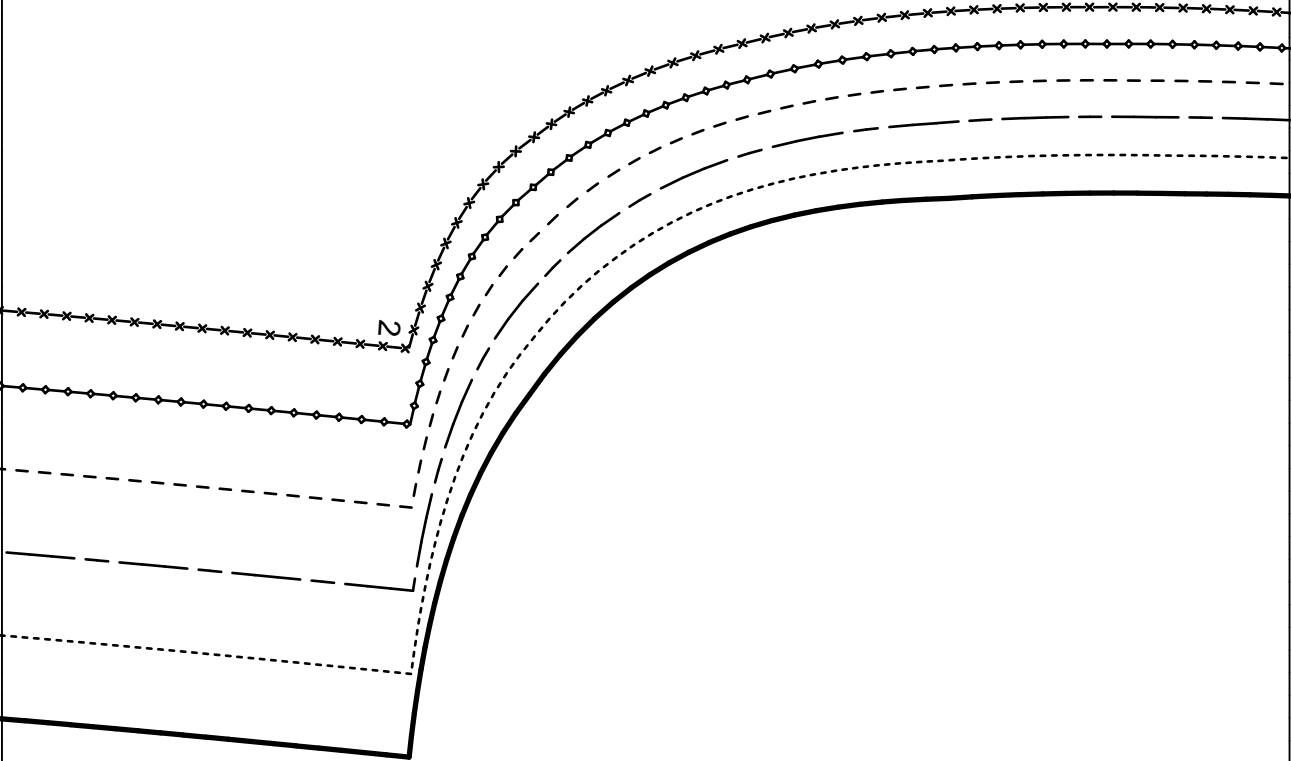

1d

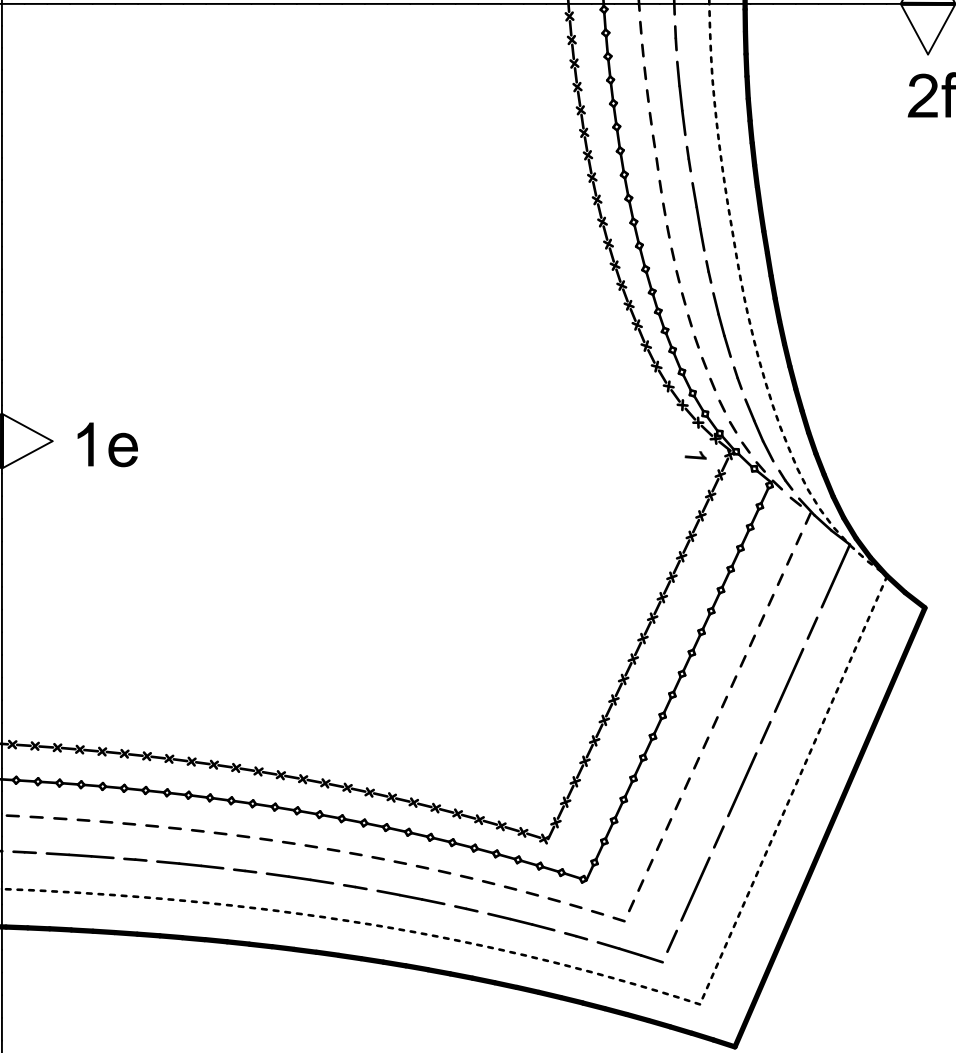

Kontrollquadrat / test square

Seitenlänge / side length
10 cm (4 inches)

4a

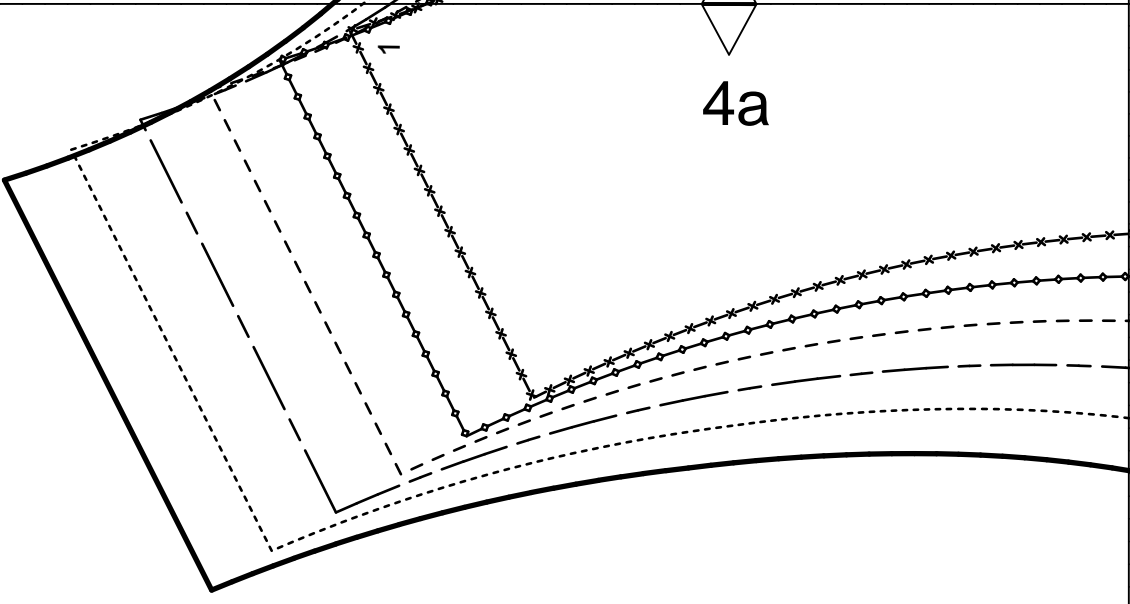

3a

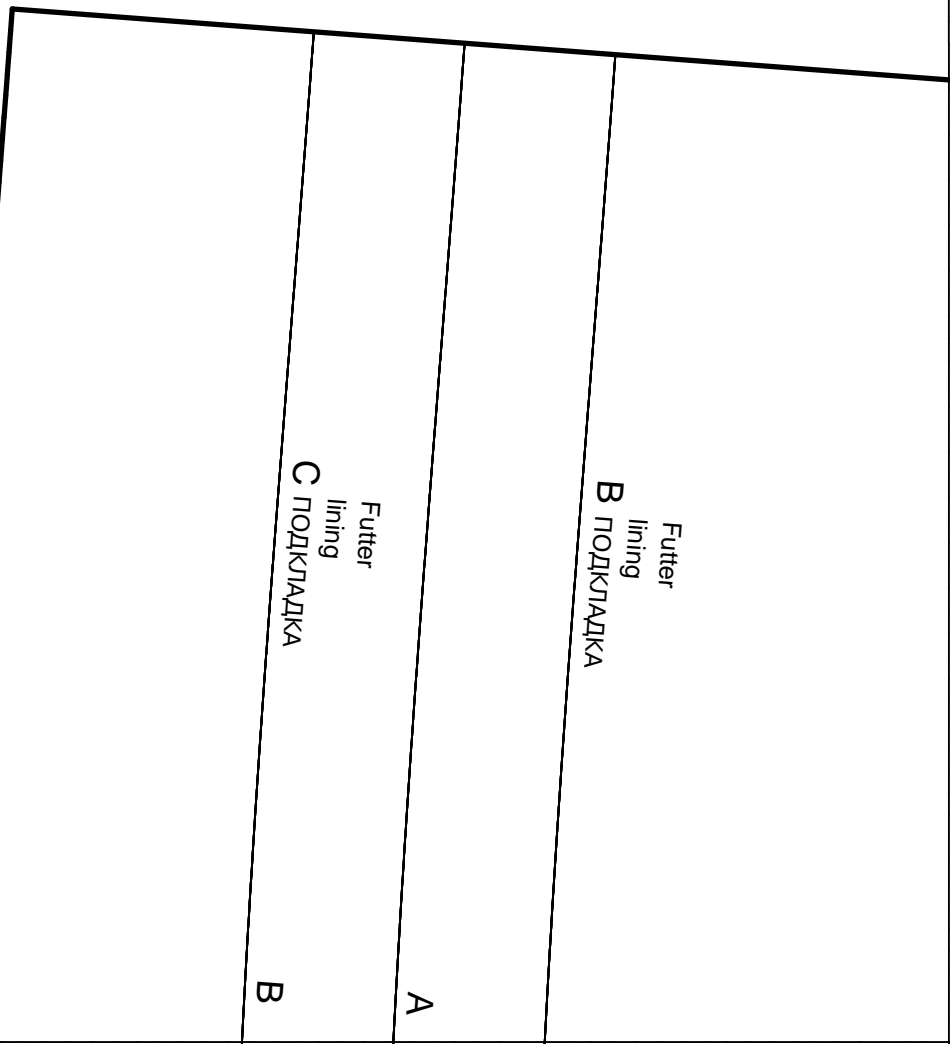

2a

C

B

A

Futter lining
ПОДКЛАДКА

Futter lining
ПОДКЛАДКА

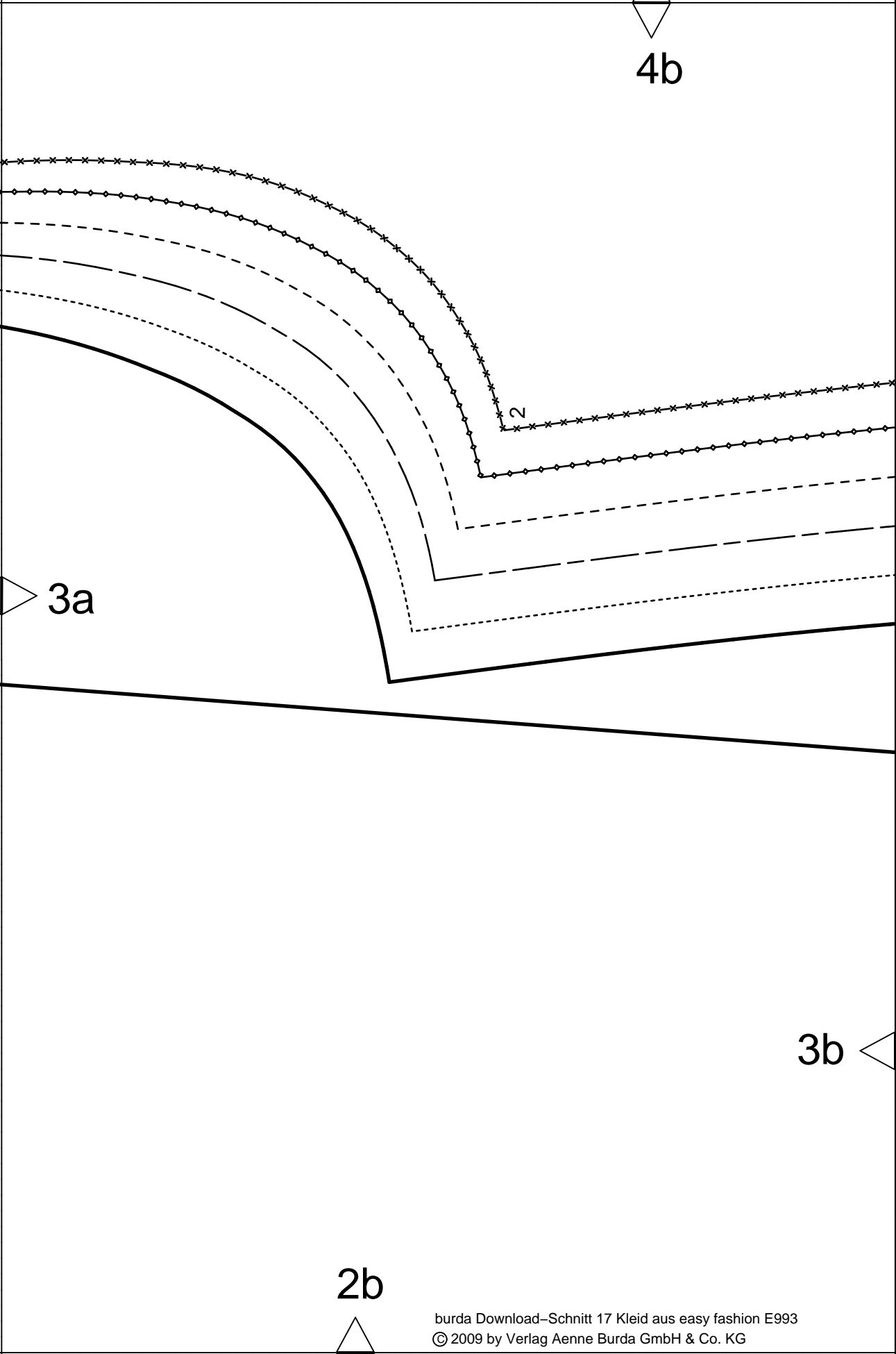

4b

2

3a

3b

2b

4c

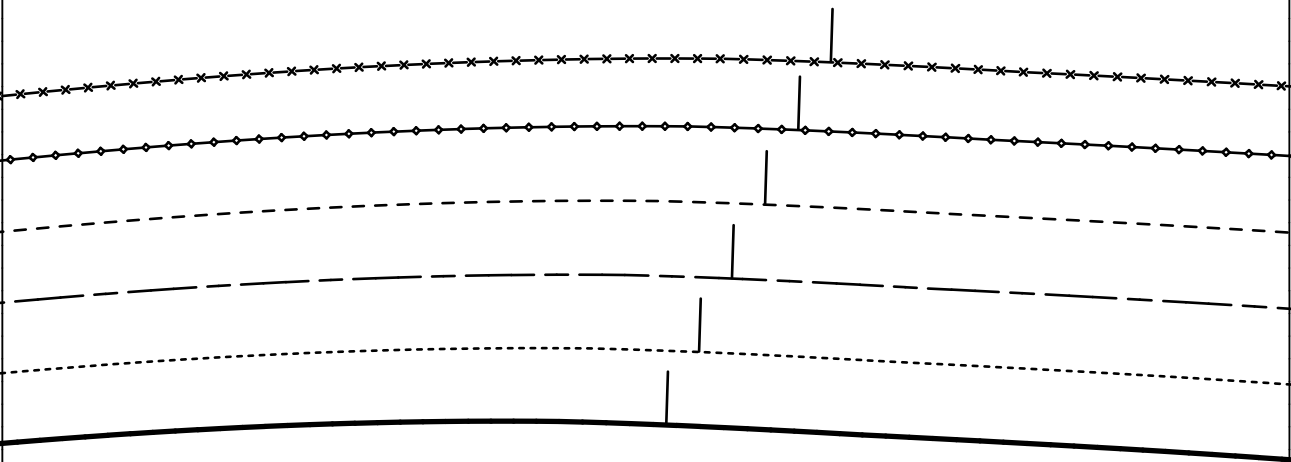

rückwärtige Mitte Stoffbruch Fadenlauf
center back fold straight grain
ЗАДНЯЯ СЕРЕДИНА СГИБ ДОЛЕВАЯ НИТЬ

3b

3c

2c

4d

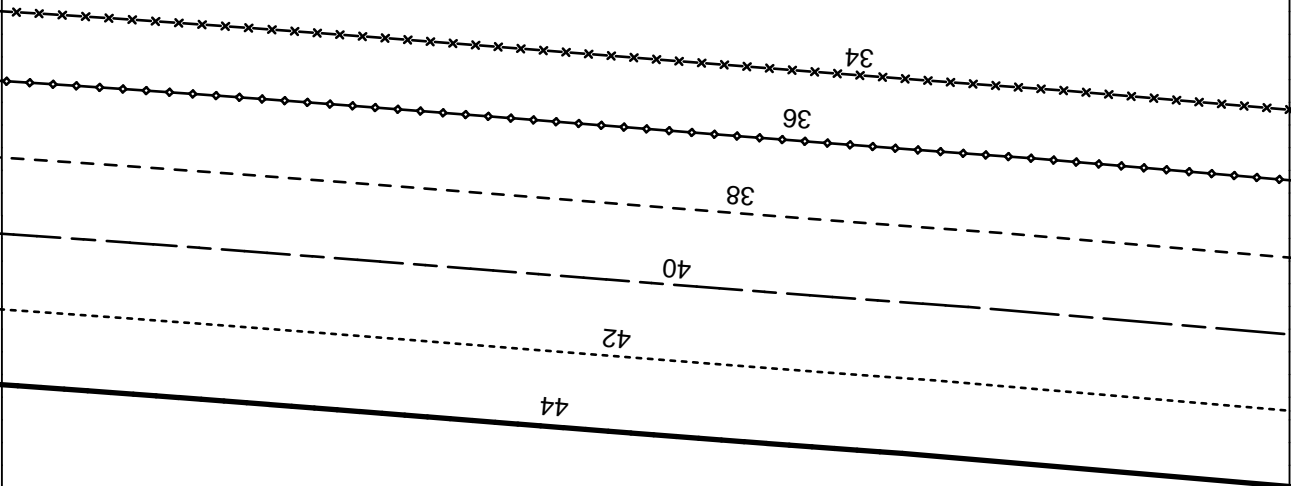

Taille
waist
ТАЛИЯ

3d

3c

2d

4e

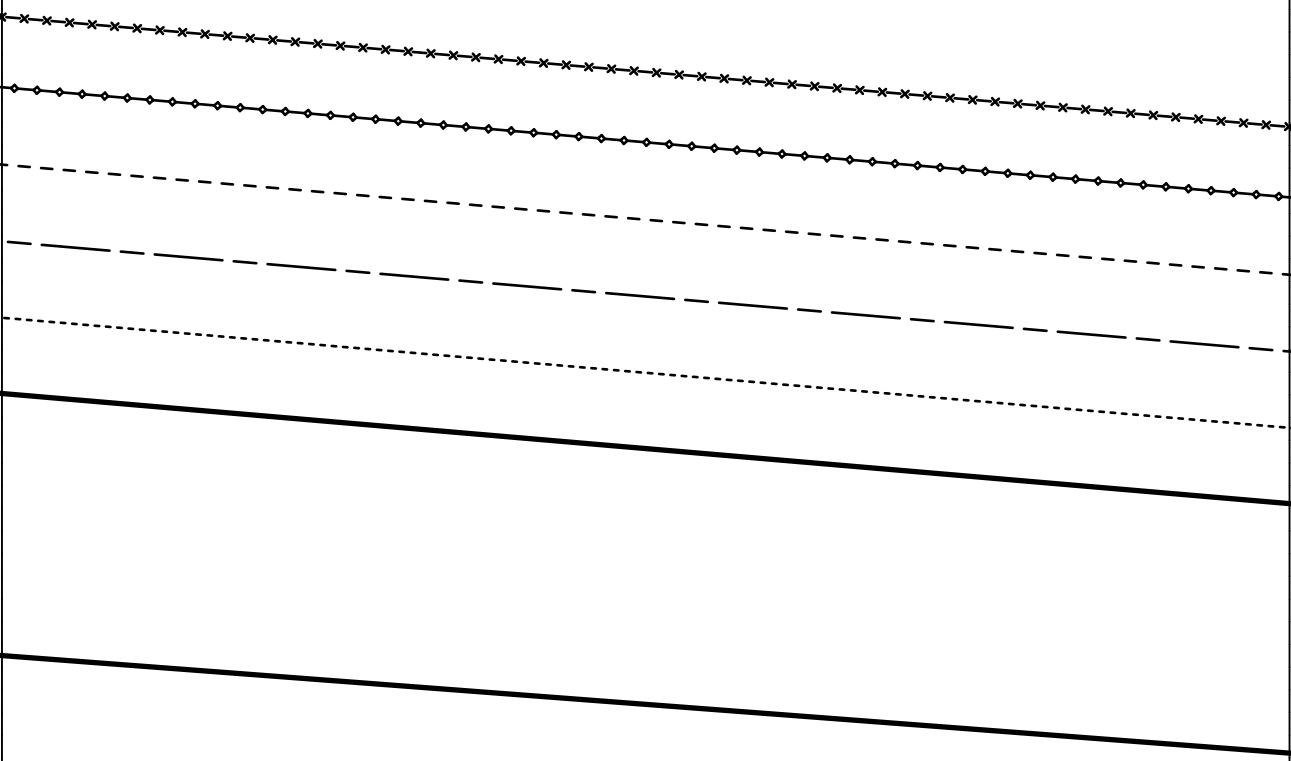

3d

3e

2e

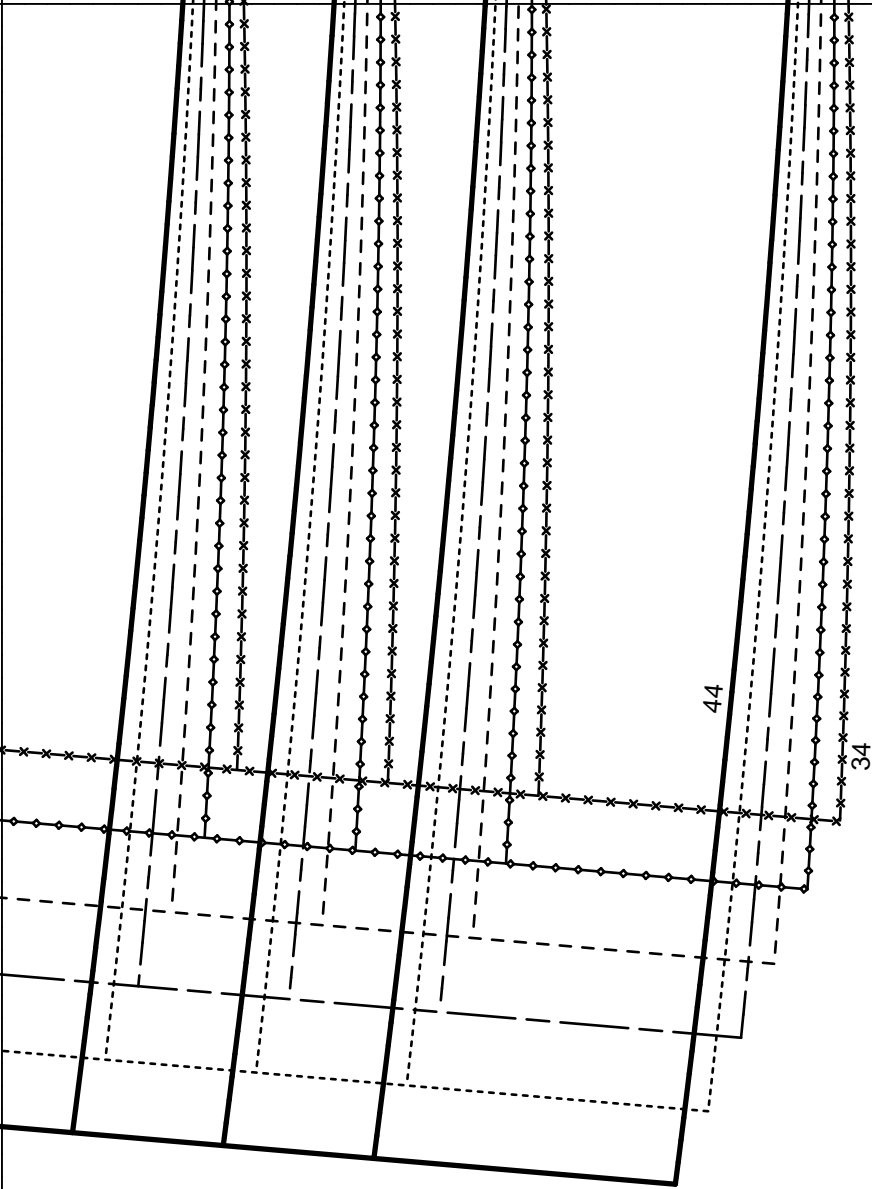

4f

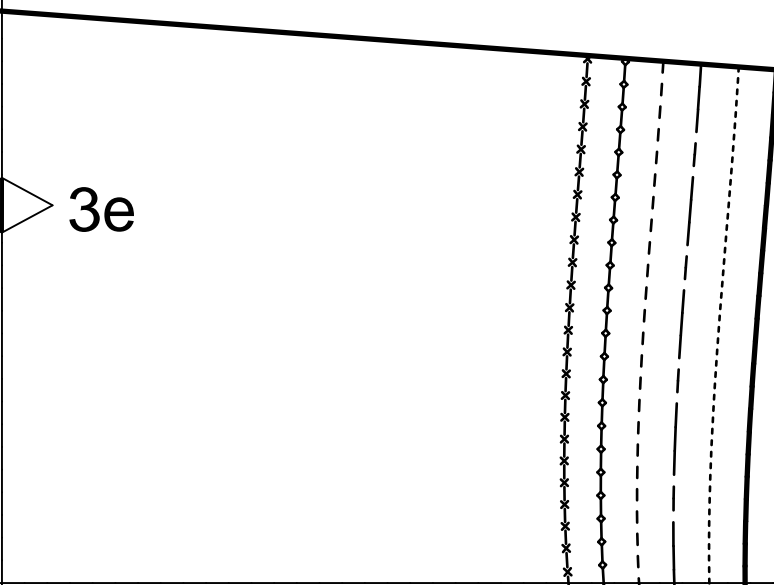

3e

2f

burda[®]
www.burdastyle.com

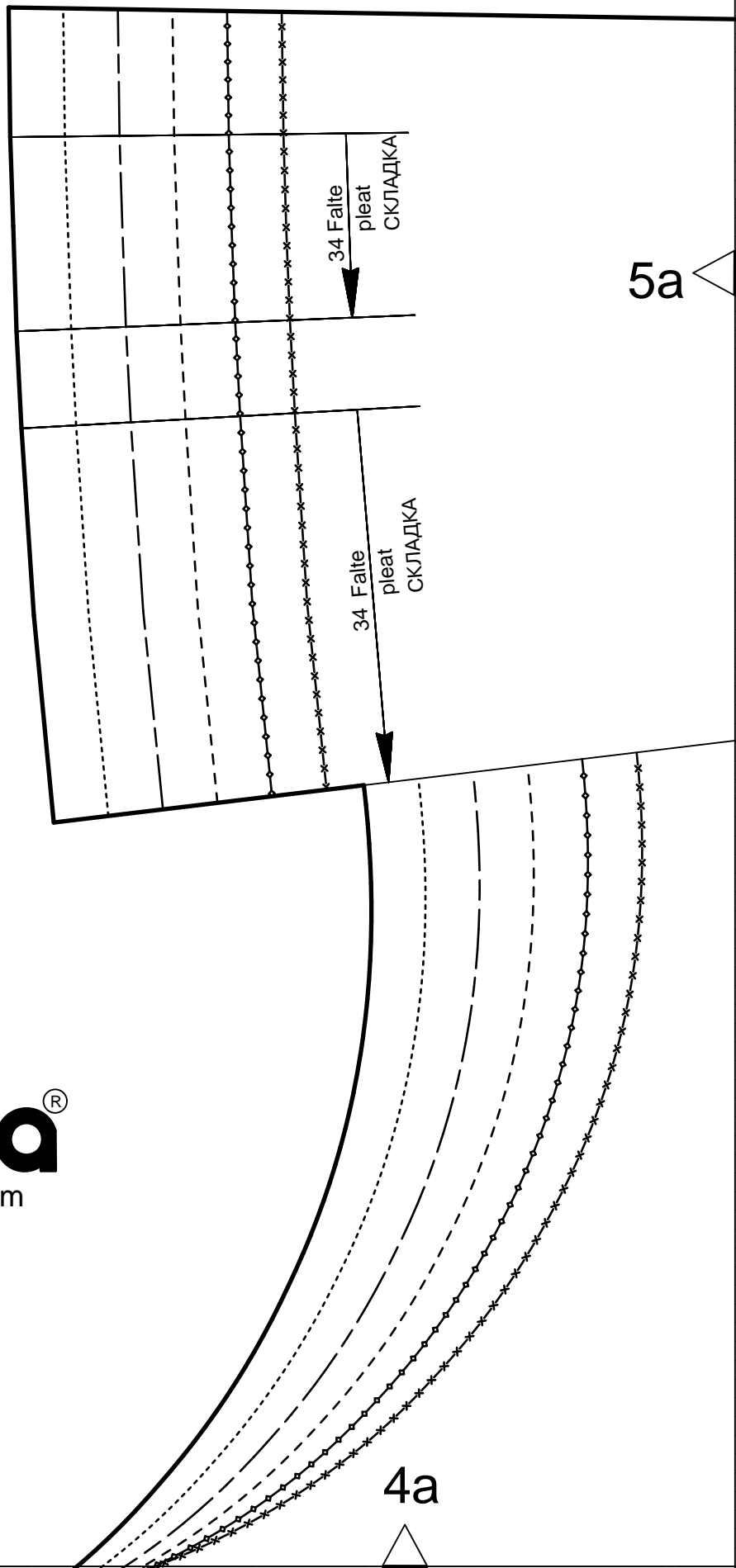

Stoffruch Fadenlauf
fold straight grain
СЛИБ ДІОЛІБАЯ НІТЯ

5a

Naht
seam
ШОБ

5b

4b

1

Vorderteil
front
ПЕРЕД, ПОЛОЧКА

A, B, C

im Stoffbruch / Stoff + Futter
on the fold / fabric + lining
СГИБ ТКАНИ / ТКАНЬ + ПОДКЛАДКА



Mod. 17

burda[®]
www.burdastyle.com

Taille
waist
ТАЛИЯ

5b

5c

4c

ЛІНІЯ СЕРЕДІНЬ ПЕРЕДА
center front
vordere Mitte

5c

5d

4d

ПОДКЛАДКА
lining
Futter
fold straight grain
Stoffbruch Fadenlauf
СЛИБ ДОЛГЕВАЯ НИТЬ

5d

5e

4e

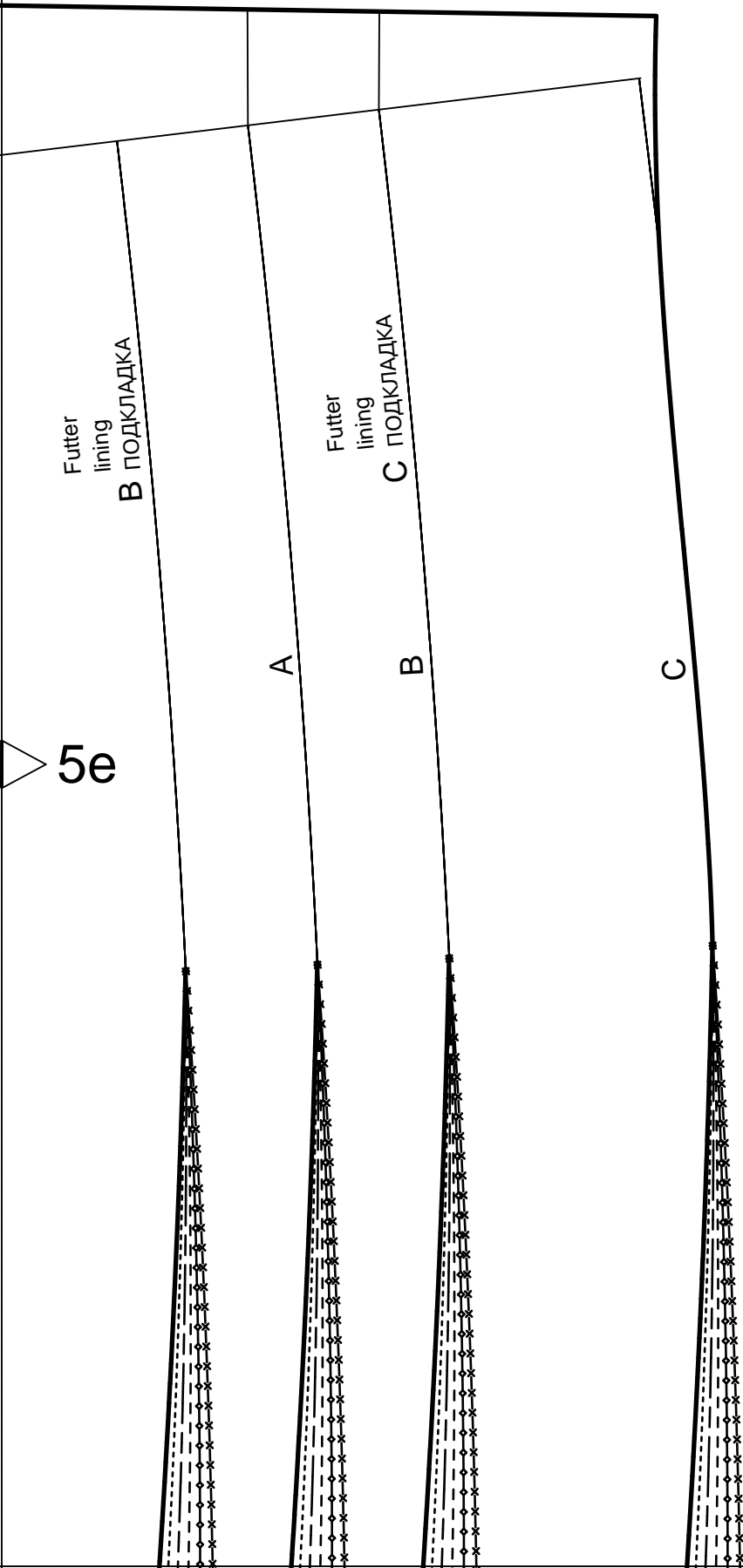

4f

